

# NACM Educational Program Integrated Remote Appearances



Jake Chatters,  
Court Executive Officer

Greg Harding,  
Information Technology Director

Superior Court of California, County of Placer

*September 3, 2020*

# Overview

1. The Goal: Authentic Experiences
2. The COVID Caveat
3. The Foundational Questions
4. The Integrated Approach
5. The Quick Demonstration
6. The Fast Lessons Learned
7. The Time for Your Questions

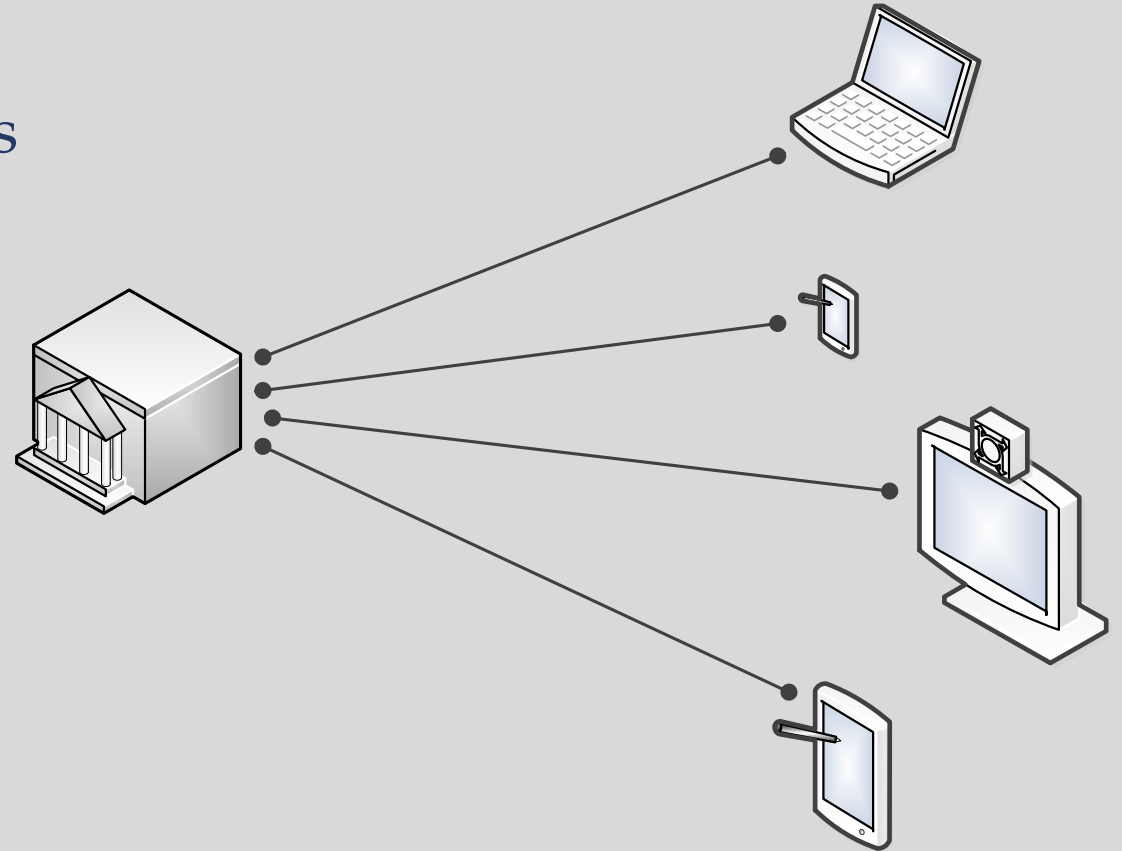

# The Goal

Remote appearances should be integrated into the court process and provide an authentic court experience, to the greatest extent possible.

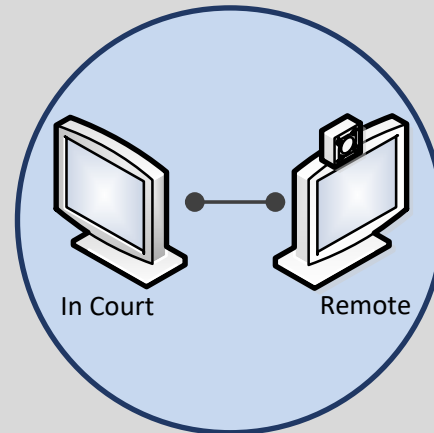

# The Goal: Authentic Experiences

For Court Users Accessible and Fair.

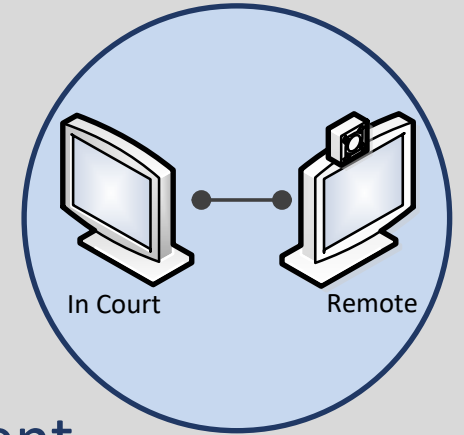

For Clerk's Office/Processing Staff Predictable and Efficient.

For Courtroom Staff Staged and Controlled.

For IT and Administrative Staff Secure and Financially Sustainable.

For Judicial Officers Effective and Productive.



# The Goal: Authentic Experiences

We have to create  
remote appearance solutions

that are not stand alone solutions  
but are instead

fully integrated into our  
processes and core business systems.

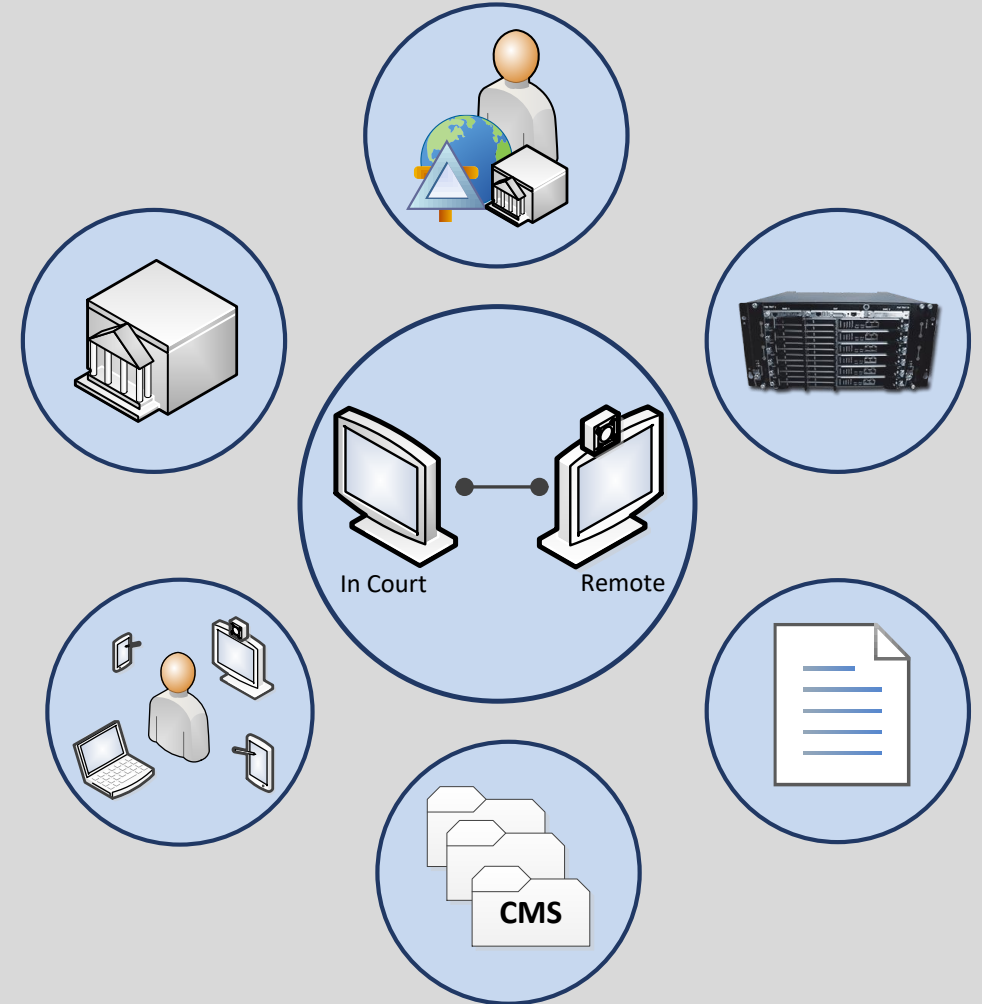

# The COVID Caveat

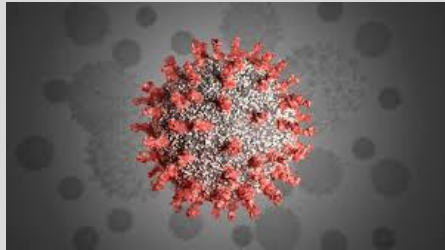

Spring 2020 =  
Nearly overnight expansion of remote  
court appearances everywhere.

Placer Superior Court pilot phase in  
December 2019.

Planned to share @ NACM August 2020.



## INFORMATION REGARDING CORONAVIRUS

[COVID-19 Webpage \(Includes All Public Notices, Orders and FAQs\)](#)

[COVID-19 - Current Court Services Notice \(Detailed\) - Updated July 29, 2020](#)

[COVID-19 - Changes in Court Operations - as of July 29, 2020](#)

[COVID-19 - Face Covering Requirements - Effective July 08, 2020](#)

[COVID-19 - Physical Distancing Protocol - Updated July 15, 2020](#)

[COVID-19 - Requisitos de cobertura facial' – A partir del 08 de julio de 2020](#)

[COVID-19 - Court Service Plan for Criminal Law, as of July 29, 2020](#)

[COVID-19 - Court Service Plan for Civil Law, as of July 09, 2020](#)

[COVID-19 - Court Service Plan for Family Law, as of July 29, 2020](#)



# Planned Pilot Implementation

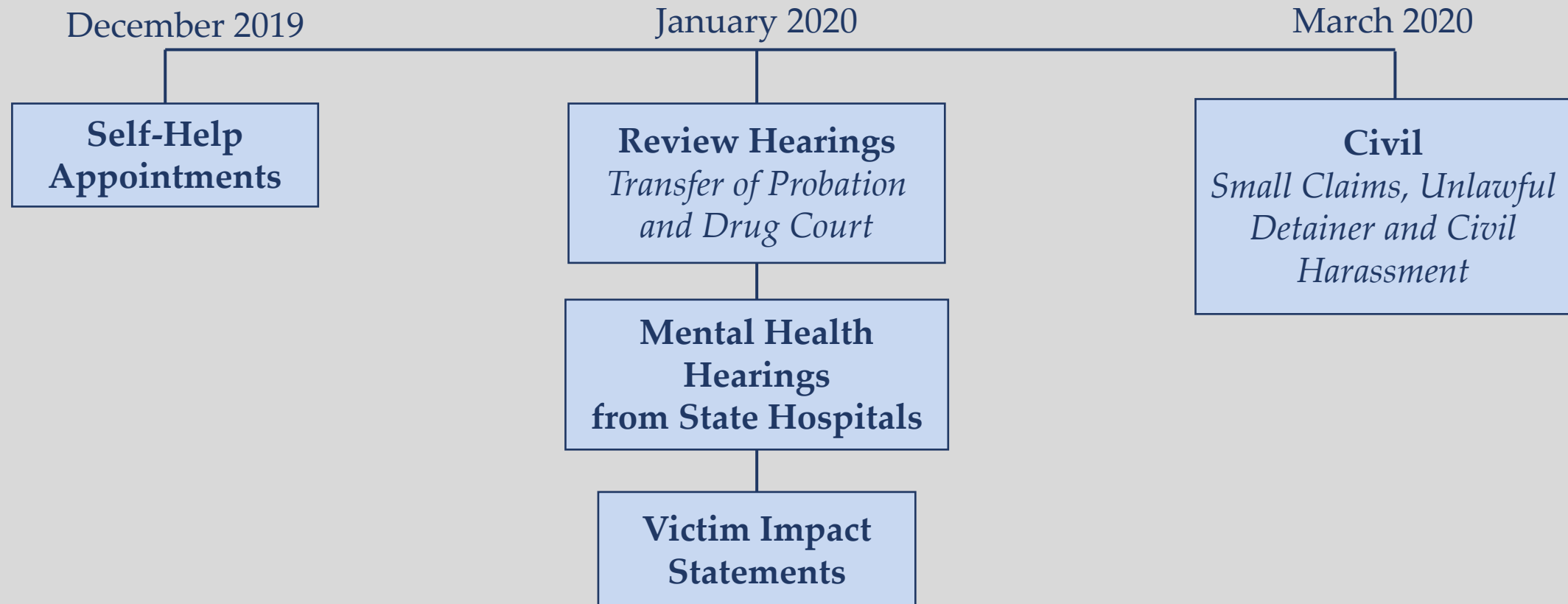

# COVID-19: Expansion of Hearing Types

## Criminal

- Arraignments
- Out-of-Custody Pre-Trial Hearings
- Mental Health
- Drug Court
- Transfer of Probation
- Victim Impact Statements

## Family Law

- Adoptions
- Restraining Orders
- Termination of Parental Rights
- Freedom of Custody & Control
- Mandatory Settlement Conferences
- Evidentiary Hearings & Long Cause Trials
- Default/Court Judgement

## Civil

- Temporary Guardianship & Conservatorship
- Restraining Orders
- Firearms Petitions
- Unlawful Detainer
- Small Claims
- Evidentiary Hearings & Trials (Available)
- Mandatory Settlement Conferences
- Habeas Corpus

\*System enabled for these hearings – many optional by video and not all have been requested.





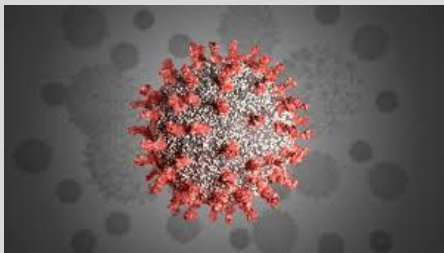

# The COVID Caveat

Emergencies require fast action.

Courts responded to preserve access and keep systems moving.

Our challenge now = convert from crisis to normalcy.

Spoiler alert – most of the questions haven't changed.  
(in our opinion)



# The Foundational Questions

How do we hold an authentic court appearance by video?

What hearings are eligible? How do we handle disruptive behavior?

Who is eligible to appear?

How do we handle disqualifications?

WHAT ABOUT EVIDENCE?

How do we know it is them?

Can they see us?

How do they connect?

Does it require pre-approval?

Is it secure?

Which app?

How do we know who is appearing?

Can they hear us?

What about computer viruses?

Is it legal?

Are there fees?

What if users need help?

How do we document agreements?



# The Foundational Questions

How do we hold an authentic court  
appearance by video?

## Policy Design

Due Process/Eligibility

Scheduling

Productive Hearings

Evidence

Public End User Support

## System Design

Remote Appearance Tool

CMS Integration

Courtroom A/V Integration

Identity Management

Evidence Sharing

Evidence Sharing -- Security



An Integrated  
Approach:  
The Placer Superior  
Court Remote  
Appearance System  
Policy Design

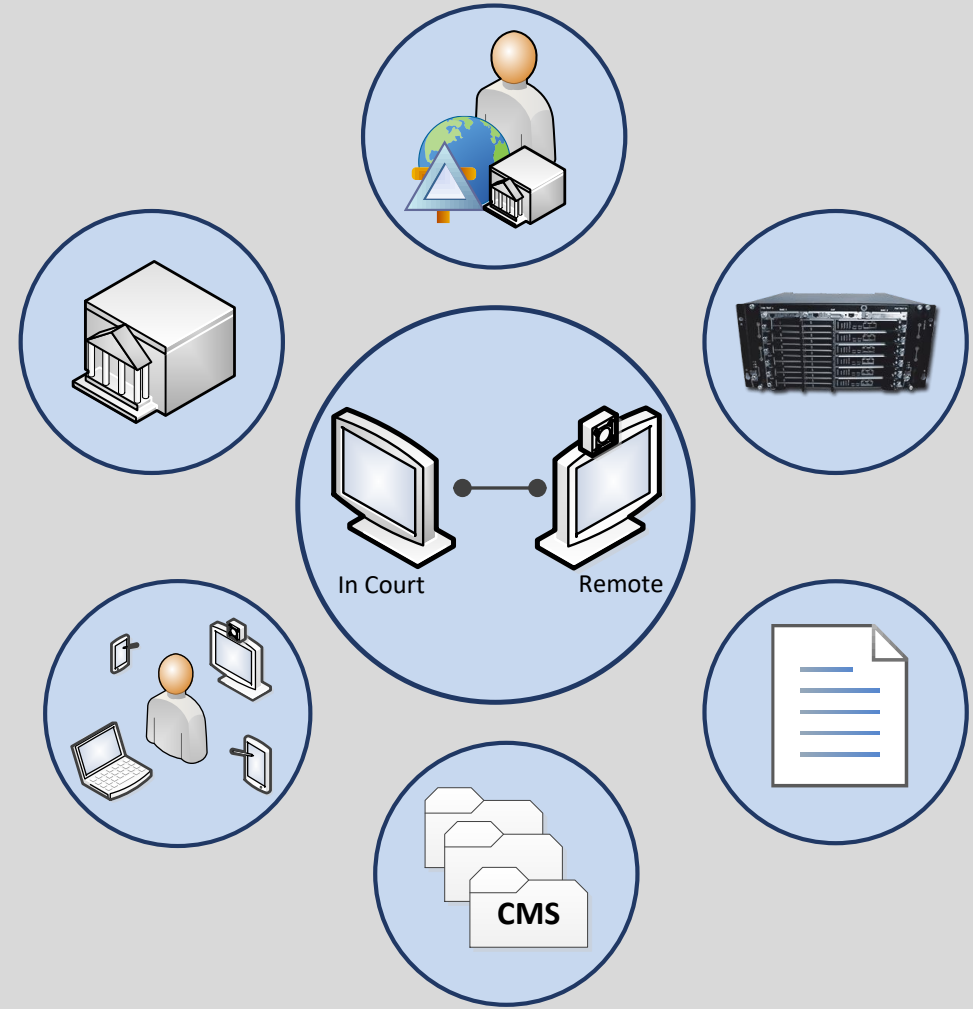



# An Integrated Approach Due Process/Eligibility

## Define hearings that are default eligible:

HEARING OR CASE TYPE	APPEARANCE TYPE	APPROVAL REQUIRED?	FORMS	FILING DEADLINES
1. Temporary Guardianship & Conservatorship 2. Restraining Orders 3. Firearms Petitions	In-Person, but telephone or video (depending on hearing type) may be available by request	Yes.	File and notify opposing party with PL-CW009 - Request to Appear Remotely; Non-Evidentiary Hearing.	As soon as practicable, but no fewer than five (5) days prior to the hearing whenever possible.
Evidentiary hearings & trials (except LID Short Cause Trial)	In-Person, but video may be available by request	Yes. Opposing party can also object.	File and serve opposing party a request through PL-CW010 - Request to Appear by Video; Trial or Evidentiary Hearing.  To object, file and serve PL-CW011 - Response to Request to Appear by Video; Trial or Evidentiary Hearing.	For filing party, no later than five (5) court days before hearing.  For objection, no later than two (2) court days before the hearing.
Unlawful Detainer, Short Cause Court Trial	In-Person, but video may be available by request	No. Opposing party can object.	File and notice opposing party with PL-CV015 Notice of Intent to Appear by Video.  To object, file PL-CV013 Response to Intent to Appear by Video.	For filing party, 10 court days before hearing. For objection, six (6) court days before the hearing.  See PL-CV012 for more information.
Small Claims	Video	No. Video appearance is mandatory.	To have any witnesses appear remotely, file PL-CV016.  See the Small Claims Packet PL-CV017 for more information about scheduling and	As soon as practicable, but the PL-CV016 no fewer than two (2) days prior to the hearing whenever possible.

## Define hearings that are subject to approval:

SUPERIOR COURT OF THE STATE OF CALIFORNIA, COUNTY OF PLACER

<b>NOTICE OF EVIDENTIARY HEARING</b> (Name, Date, Time, and Address)	<b>FOR COURT USE ONLY</b>
TELEPHONE NO. FAX NO. EMAIL ADDRESS COURT Justice Center Drive P.O. Box 60071 Roseville, CA 95618-0712	COURT Justice Center Drive P.O. Box 60071 Roseville, CA 95618-0712
<b>RESPONSE:</b>	<b>DATE:</b> _____
<b>TYPE OF HEARING:</b>	<b>TIME:</b> _____
<b>DATE:</b> _____	<b>DEPT:</b> _____

1. I am the  petitioner  defendant  other (name) \_\_\_\_\_

2. I request the court to allow me to appear by video from the following email address: \_\_\_\_\_

3. I request to appear by video for the following reason: \_\_\_\_\_

4. I understand that the court may decide at any time to require a personal appearance and continue the hearing.

5. I understand that except as permitted in California Rule of Court, rule 1.105, court proceedings shall not be postponed, rescheduled, or terminated.

I have read the provisions of the State and Local Rule 12.24, regarding video appearance requirements, as well as California Rule of Court, rule 1.105, and Code of Civil Procedure 147.3 for related telephone appearance requirements.

Date: \_\_\_\_\_

\_\_\_\_\_  
 PRINTED NAME SIGNATURE

## Define hearings that require agreements:

SUPERIOR COURT OF THE STATE OF CALIFORNIA, COUNTY OF PLACER

<b>NOTICE OF EVIDENTIARY HEARING</b> (Name, Date, Time, and Address)	<b>FOR COURT USE ONLY</b>
TELEPHONE NO. FAX NO. EMAIL ADDRESS COURT Justice Center Drive P.O. Box 60071 Roseville, CA 95618-0712	COURT Justice Center Drive P.O. Box 60071 Roseville, CA 95618-0712
<b>RESPONSE:</b>	<b>DATE:</b> _____
<b>TYPE OF HEARING:</b>	<b>TIME:</b> _____
<b>DATE:</b> _____	<b>DEPT:</b> _____

1. I am the  petitioner  defendant  other (name) \_\_\_\_\_

2. I request the court to allow me to appear by video from the following email address: \_\_\_\_\_

3. I request to appear by video for the following reason: \_\_\_\_\_

4. I understand that the court may decide at any time to require a personal appearance and continue the hearing.

5. I understand that except as permitted in California Rule of Court, rule 1.105, court proceedings shall not be postponed, rescheduled, or terminated.

I have read the provisions of the State and Local Rule 12.24, regarding video appearance requirements, as well as California Rule of Court, rule 1.105, and Code of Civil Procedure 147.3 for related telephone appearance requirements.

Date: \_\_\_\_\_

\_\_\_\_\_  
 PRINTED NAME SIGNATURE





# An Integrated Approach Scheduling

Define hearings that parties can self-schedule:

 SUPERIOR COURT OF CALIFORNIA  
COUNTY OF PLACER

**VCourt™ Remote Appearances** with VCourt™ Evidence

Welcome to Placer VCourt. Select an option below to continue.

*Note: Sign In is required to schedule video appearances or participate in Evidence Sharing.*

Schedule a remote telephone or video appearance for a case with the Court.	Access online evidence sharing for uploading and managing documents for your case.	Cancel a previously scheduled remote telephone or video appearance.
<input type="button" value="Schedule"/>	<input type="button" value="Evidence"/>	<input type="button" value="Cancel"/>

...or [continue as guest](#) (limited functionality)

Define hearings that are routinely set with justice partners and batch schedule:

XXXX-NEED IMAGE-  
XXXX

Define hearings that staff schedule for the parties:

XXXX-NEED IMAGE-  
XXX

Automated method of sending unique links and pins to participants.



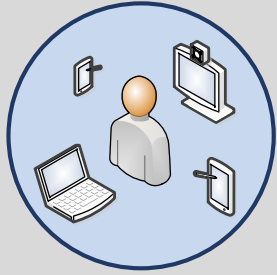

# An Integrated Approach Productive Hearings

## Simple access to hearing:

**SUPERIOR COURT OF CALIFORNIA  
COUNTY OF PLACER**

This is a confirmation for **Jake Chatters** from **Placer Superior Court**. You have been scheduled for the remote appearance(s) shown below.

**Payment Confirmation**  
Total Amount Paid: \$0.00  
Confirmation Number: 551909062266  
For payment issues: [postmasters@placerco.org](mailto:postmasters@placerco.org) or 916-408-6000

**How to Join Your Remote Event**  
On the date & time of your event, connect:  
 By VIDEO. Use your video capable device. Click on the **Conference ID** or video link shown below (or paste the link into your browser).  
You will need the **Conference ID** and **Conference PIN** shown below.

**Remote Appearances Scheduled**

Event Date & Time	Dept	Case Number	Event Description	Amount Paid	Conference ID*	Conference PIN	Event Instructions
<input checked="" type="checkbox"/> 9/6/2019 9:00 AM	D642	TestngD42	Test 123	\$0.00	39729056	5053	Video Hearing

\* **Conference ID**    **Video Link**  
39729056    <https://remoteppearance.placerco.org/conference/join?autoJoinPasscode=39729056&autoJoinPin=5053>

## Detailed instructions:

**SUPERIOR COURT OF CALIFORNIA  
COUNTY OF PLACER**

**Video Appearances Packet for  
Small Claims and Unlawful Detainer  
Pilot Program - 2020**

**In Court** ↔ **Remote Location**

Placer County Superior Court now offers video appearances for Small Claims and Unlawful Detainer cases. This is an optional service wherein you and/or the other party appear from a remote location using any device capable of capturing and displaying a clear audio and visual stream at a sufficient internet speed.

Use this packet if you are interested in requesting a video appearance in your next hearing.

**Contents**

- IF YOU WISH TO APPEAR BY VIDEO FOR YOUR NEXT HEARING..... 2
- IF YOU ARE NOTIFIED THAT THE OTHER PARTY INTENDS TO APPEAR BY VIDEO..... 3
- SCHEDULING YOUR VIDEO APPEARANCE..... 4
  - Two to Three Days Before Your Hearing..... 4
  - On the Day of Your Hearing..... 4
- Reminders..... 4
- SUBMITTING EVIDENCE FOR VIDEO APPEARANCES..... 5
  - Uploading Evidence..... 5
  - Viewing Evidence..... 5

Revision Date: 3/3/20

## Facilitate stipulations to SJOs to avoid day of continuances:

**SUPERIOR COURT OF THE STATE OF CALIFORNIA  
IN AND FOR THE COUNTY OF PLACER**

Tibbet, David F. et al vs. Ford Motor Co. et al

**FOR COURT USE ONLY**

**STIPULATION FOR THE APPOINTMENT OF  
COMMISSIONER AS TEMPORARY JUDGE**

CASE NUMBER:

It is understood between the undersigned attorneys and parties that the pending matter has been assigned to a Superior Court Commissioner for the County of Placer, and that his/her appointment as a Superior Court Commissioner is in accordance with Article Six, Section Twenty-Two of the Constitution of this State and further that said Commissioner has been appointed as a Temporary Judge pursuant to an order of the Presiding Judge of this Court under the authority of Article Six, Section Twenty-Two of the Constitution and Section 259, Subdivision (f) of the Code of Civil Procedure of this State, and that upon such appointment said Commissioner has taken the oath of office as to all matters assigned.

It is therefore stipulated between the undersigned attorneys and parties that said Commissioner or any other Commissioner appointed as set forth above shall bear the within action sitting as a Judge Pro Tempore.

It is further stipulated that said Commissioner, or any Commissioner appointed as set forth above shall, by this signed document, be vested with the authority to hear any future or further hearings or the trial in this case, whether contested or uncontested, as a Judge Pro Tempore.

Date: 02/11/2020

(Plaintiff/Petitioner) \_\_\_\_\_ (De)

\_\_\_\_\_  
(Attorney for Plaintiff/Petitioner) \_\_\_\_\_ (Attor

**SignNow**



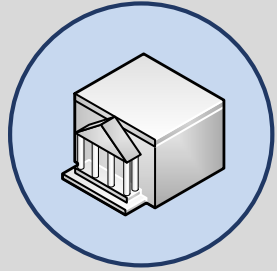

# An Integrated Approach Productive Hearings

## Caller Management

The screenshot shows the ConferenceManager interface. On the left is a 'Dial Out' panel with fields for Name (Self-Help CompanionWeb), Phone, and Extension, and options for Audio or Video. The main area displays a list of participants for Conference ID 67000. Each participant has a 'private' status and buttons for 'mute', 'hold', and 'disconnect'. The 'mute' button for the last participant is highlighted in orange.

Court Staff manage callers (*hold, mute, end, subconference*) from a screen separate from video call itself.

## Capability for same-day-agreements

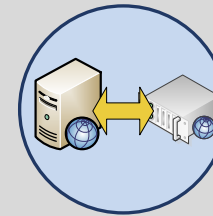

CMS generated forms integration with signature solution.





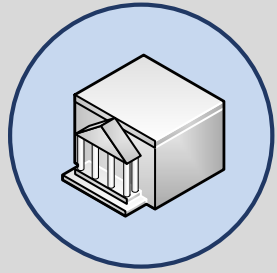

# An Integrated Approach Evidence Sharing

## Court involvement in discovery



Except for small claims and landlord/tenant.

## Court viewing of exhibits during hearing

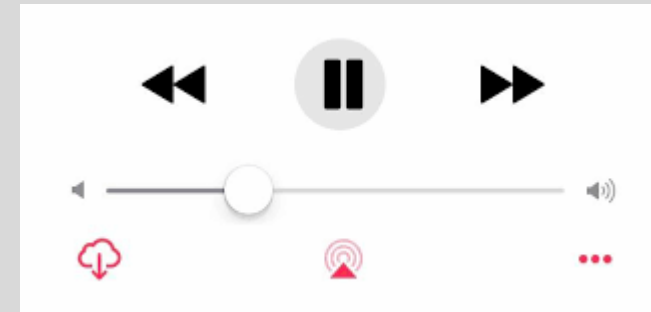

Hold that thought for a couple more minutes.



# An Integrated Approach: The Placer Superior Court Remote Appearance System System Design

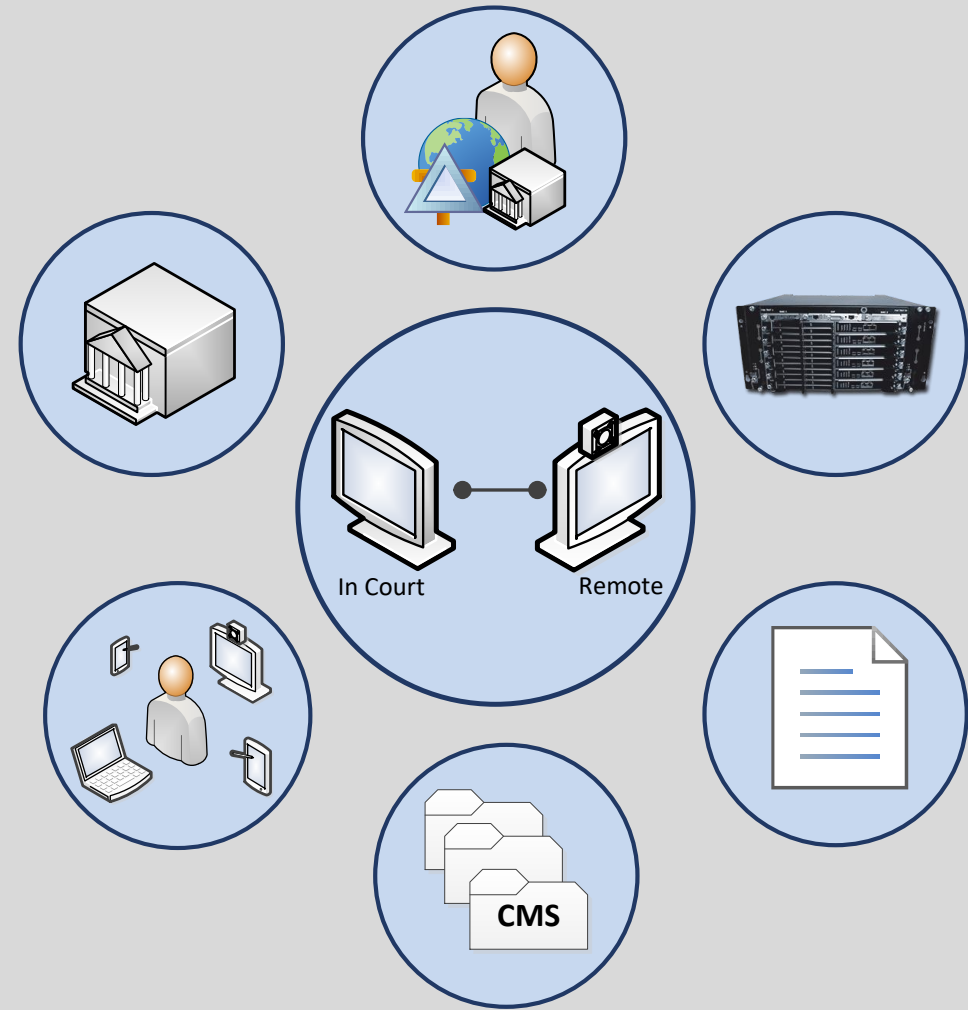

# An Integrated Approach: The Placer Superior Court Remote Appearance System System Design

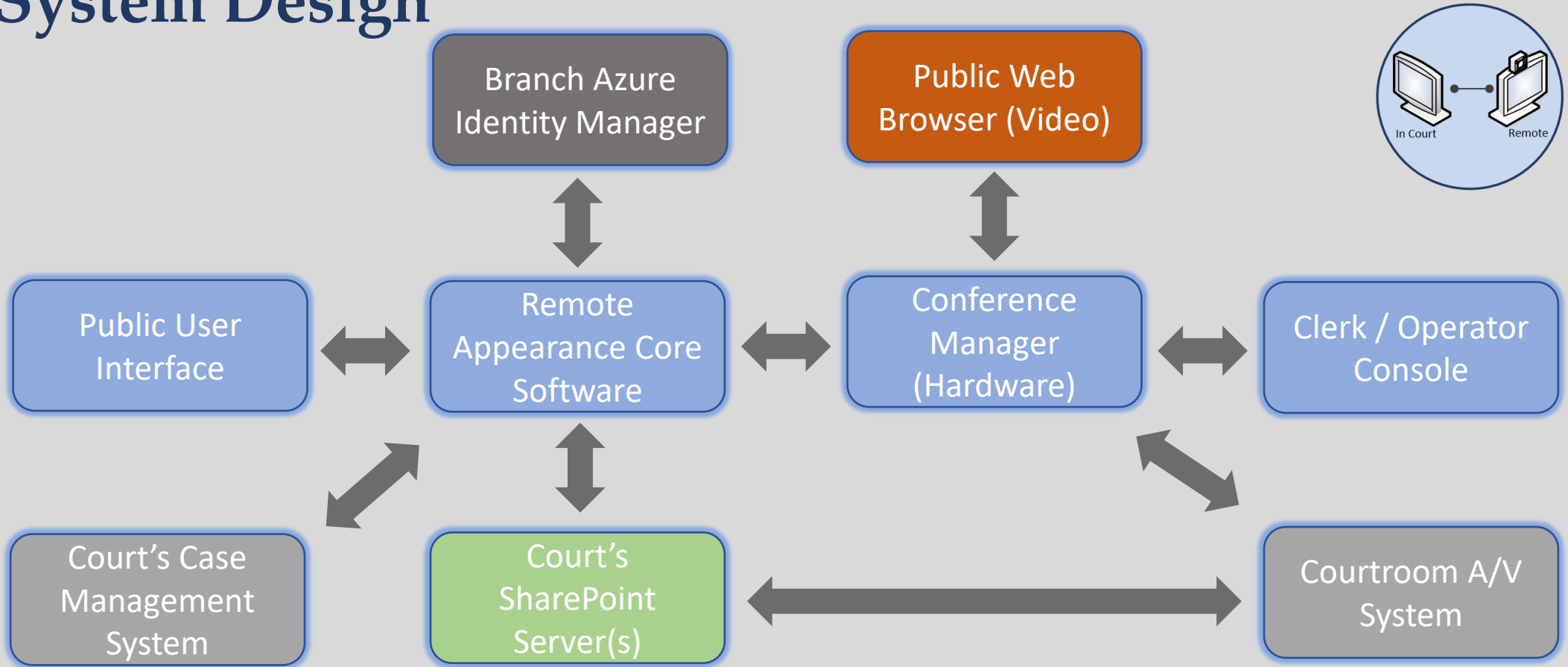

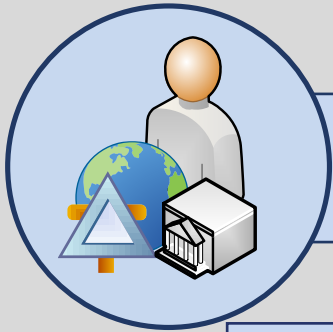

## Remote Appearance Solution – Customized Software

### VCourt: Streamwrite Inc.

- Leveraged existing telephonic vendor and technology
- Enhanced system to support video conferences
- Subsequently enhanced system to support evidence sharing
- Automates eligible hearings, fee collection, identity management, and email notifications of events.



## SUPERIOR COURT OF CALIFORNIA COUNTY OF PLACER

### VCourt™ Remote Appearances *with VCourt™ Evidence*

Welcome to Placer VCourt. Select an option below to continue.

*Note: Sign In is required to schedule video appearances or participate in Evidence Sharing.*

Schedule a remote telephone or video appearance for a case with the Court.

**Schedule**

Access online evidence sharing for uploading and managing documents for your case.

**Evidence**

Cancel a previously scheduled remote telephone or video appearance.

**Cancel**

VCourt Landing Page



## Remote Appearance Solution - Hardware

### Evergreen Cypress MCU (On premises)

- Connects external connections to courtroom
- 86 Concurrent Video Connections
- Open-source technology (WebRTC)
- Allows Video Call with minimal bandwidth
- Uses SIP and the primary protocol
- Requires a Turn Server

### CO-Turn Harden Application

Court selected the harden application out of concerns of vulnerabilities with the software.

### Computnetix Companion Server

Allows the MCU to support Computer to Computer Connections with Screen sharing capabilities.

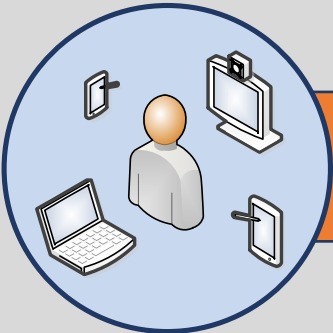
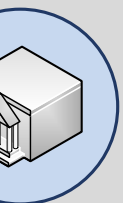
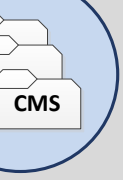

# Remote User Connections

**State Hospital**  
Uses a direct IP Address

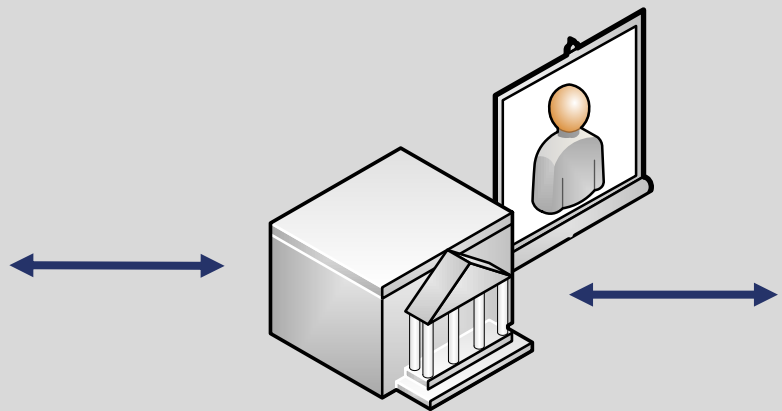

**Laptop or Desktop Computer**  
Microsoft, Apple, Dell, etc. with  
Chrome version 54 or above, a webcam  
and microphone that is on Wi-Fi

**iPhone or iPad**  
Safari version 12 or above that  
is wireless or on a network

**Android Phone or Tablet**  
Chrome version 57 or above that is  
wireless or on a network

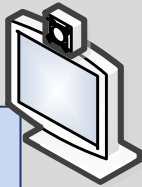
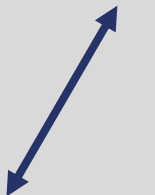

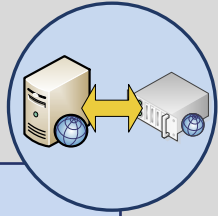
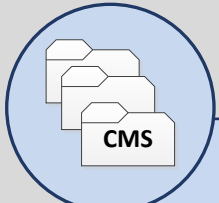
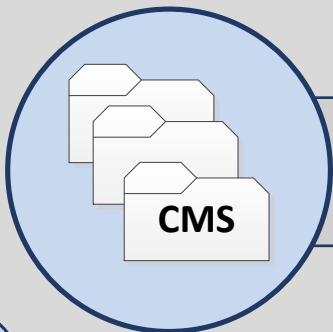

**Integrating Case Management System with Remote Appearance System  
eCourt to vCourt and Back**

CMS report of eligible



Data table of remote and evidence eligible hearings



Remote web scheduler updated to allow self-scheduling

CMS report of eligible

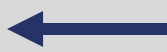

Automatic remote appearance flag sent to CMS



Court users, staff, or batch schedule video appearance takes place

ote

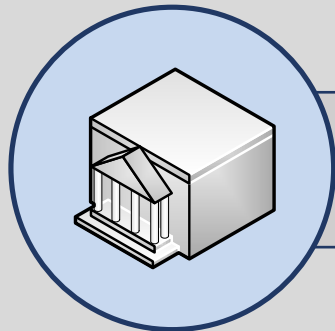

## Courtroom Audio Video System Integration

Each of the Courts five locations have different Audio Video equipment and control systems, with varying levels of complexities:

- The less advanced has a Cisco Codec and a single camera and monitor.
- The most complex system uses an AMX touchscreen to control over 75 different Audio Video components.



System had to be able to operate in all of the courtrooms, and be controlled by the Courtroom Audio Video System, therefore could not have a emailed link that started the conference.





## Evidence Sharing Solution that Replicates the In-person Process

VCourt Platform leveraged to allow for Evidence Sharing



Based on Microsoft SharePoint that is located on premise



**Certain document types are uploaded by parties online or at the court**

- Parties login using ICC Azure Identity Manager
- Uploaded files are scanned six times with four different anti-virus software applications.

Clerk is able to login and mark or admit evidence uploaded by the parties

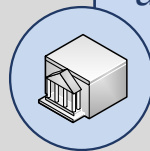

# The Quick Demonstration

Scheduling Remote Appearance  
(See [www.placer.courts.ca.gov/RAS](http://www.placer.courts.ca.gov/RAS))

Evidence: Party's View

Evidence: Clerk's View



# The Quick Lessons Learned

1. Communication with remote party is vital.
2. WiFi versus Cellular.
3. Web RTC versus App-based structure.
4. End user support remains an unresolved policy question.
5. On premises: gives high quality video but restricts concurrent connections.
6. Cloud: lower quality video but nearly unlimited concurrent connections.
7. Breakout rooms are important, but not yet high demand.
8. eSignatures can be handled same day.
9. Patience is key. Video expands access but does cost amount of courtroom efficiency.



# The Time for Your Questions

Jake Chatters,  
Court Executive Officer  
jchatters@placer.courts.ca.gov

Greg Harding,  
Information Technology Director  
gharding@placer.courts.ca.gov

Superior Court of California, County of Placer



# The Team: A Thank You

Local Justice Partners and Court  
Users

Placer Superior Court Team:

All Placer Superior Court Judicial  
Officers and Staff

Emma Dunn, Victor Taibi, Zachary  
Hazell

External Partners

Streamwrite/ATI Inc.

Snorri Ogata, Kenneth Bjork, Romulo  
Reyes – Los Angeles Superior Court

Oscar Aguirre, Marcela Eggleton, JR  
Sessions, John Yee – Judicial Council  
of California

Former Placer Team Members

Sharif Elmallah; Laila Waheed; Paulo  
Nunes.

